



Válvulas de esfera 'Basic'

Valvula de bola salida mixta colar macho r/h PE ITEM 777

REFERÊNCIA	DESCRIÇÃO	Peso líquido	Volumen (m ³)	Peso bruto	Unidades por lote
1011608	VALV. União ENC. MACHO-R/fêmea 20-1/2"	0,1687	0,02244	7,074	40
1011609	VALV. União ENC. MACHO-R/fêmea 25-3/4"	0,197	0,02244	8,2	40
1011610	VALV. União ENC. MACHO-R/fêmea 32-1"	0,324	0,03682	10,34	30
1011611	VALV. União ENC. MACHO-R/fêmea 40-1 1/4"	0,557	0,03129	11,75	20
1011612	VALV. União ENC. MACHO-R/fêmea 50-1 1/2"	0,911133	0,03682	14,24	15
1011613	VALV. União ENC. MACHO-R/fêmea 63-2"	1,365	0,04460	14,35	10



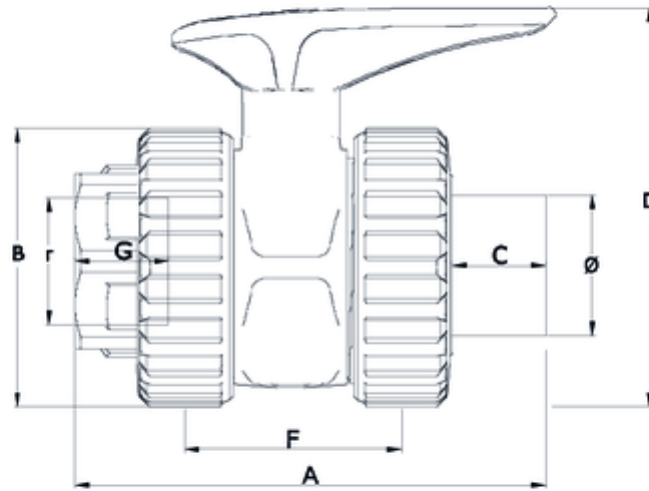

ITEM 777 | Valvula de bola salida mixta colar macho r/h PE

CÓDIGO	f	PESO (g)	DN	A	B	C	D	F	G	PN	TIPO ROSCA
11608	20-1/2"	155	15	98	52	16	78	47	17	PN16	BSP
11609	25-3/4"	197	20	107	59	19	84	51	20	PN16	BSP
11610	32-1"	324	25	131	70	23	97	66	23	PN16	BSP
11611	40-1 1/4"	557	32	150	84	25	128	72	26	PN16	BSP
11612	50-1 1/2"	830	40	167	99	31	142	77	33	PN16	BSP
11613	63-2"	1365	50	186	121	38	165	90	29	PN16	BSP





Documentação do Produto



Certificados do Produto

Certificados da Empresa

